

OPERATING INSTRUCTIONS

2
Test Equip



TYPES **1209-B** AND **BL**

UNIT OSCILLATORS

GENERAL RADIO COMPANY

732-J

OPERATING INSTRUCTIONS

TYPES 1209-B AND BL

UNIT OSCILLATORS

Form 732-J
September, 1959

G E N E R A L R A D I O C O M P A N Y
WEST CONCORD, MASSACHUSETTS, USA

SPECIFICATIONS

Frequency Range:	Type 1209-BL: 180 to 600 Mc Type 1209-B: 250 to 920 Mc
Frequency Calibration Accuracy:	±1 percent.
Warmup Frequency Drift:	±0.2%.
Frequency Control:	A four-inch dial with calibration over 270 degrees, with a slow-motion drive of about 8 turns.
Output System:	Short coaxial line with adjustable coupling loop at one end and coaxial connector on the other. Maximum power can be delivered to load impedances normally met in coaxial systems.
Output Power:	Type 1209-B: At least 200 mw into 50-ohm load at any frequency within range. Refer to curve below. Type 1209-BL: At least 300 mw into 50-ohm load at any frequency within range. Refer to curve below.
Modulation:	Plate modulation of 30% at audio frequencies can be produced by external source of 40 volts. Input impedance is about 8000 ohms. Type 1000-P6 Crystal Diode Modulator and Type 1000-P7 Balanced Modulator are recommended to avoid incidental fm. Refer to Table on page 3.
Tuned Circuit:	Butterfly, with no sliding contacts.
Power Supply Requirements:	330 v at 36 ma dc 6.3 v at 0.4 amp
Power Supply Recommended:	Refer to Table of Accessories, page 3.
Oscillator Tube:	Sylvania Type RT434.
Mounting:	Aluminum casting surrounded by spun-aluminum shield. Assembly is mounted on L-shaped panel-and-chassis piece.
Accessories Supplied:	Type 874-R22 Cable, Type 874-C58 Cable Connector, Jones socket, and telephone plug.
Accessories Available:	Refer to Table on page 3.
Dimensions:	Height 6¼ in., width 9¼ in., depth 7 in., over-all.
Weight:	6¼ lb.

GENERAL RADIO EXPERIMENTER references: Vol 24 No. 12, May, 1950
Vol 29 No. 11, April, 1955
U. S. Patent No. 2,548,457 Vol 32 No. 8, January, 1958

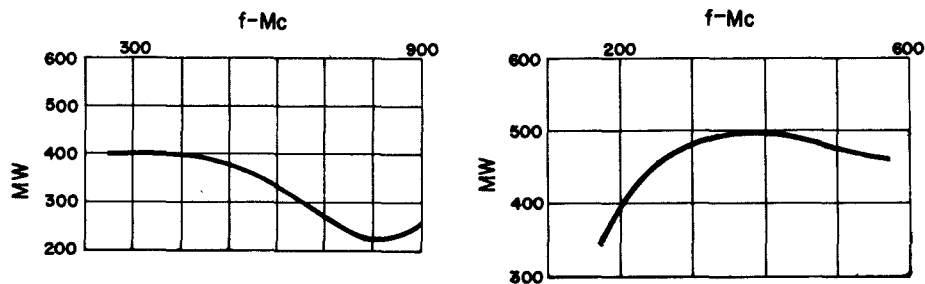

Typical output characteristics of Types 1209-B (left) and 1209-BL (right) Unit Oscillators. Output with 300-v Type 1201 Unit Regulated Power Supply is reduced to about 0.6 of values shown. Outputs with Type 1216 or 1263 Power Supply are further reduced.



Figure 1. Type 1209-B Unit Oscillator
(Type 1209-BL identical in appearance except for dial calibration)

TYPES 1209-B AND 1209-BL UNIT OSCILLATORS

Section 1 INTRODUCTION

1.1 PURPOSE. The Types 1209-B and 1209-BL Unit Oscillators (Figure 1) are general-purpose radio-frequency power sources covering the ranges of 250 to 920 Mc and 180 to 600 Mc, respectively. These members of the convenient Unit Instrument line can be used to drive bridges, slotted lines, impedance comparators, and other measuring equipment. Used with a voltmeter and attenuator, they provide accurately known output voltages for the testing of receivers. Direct amplitude modulation is possible over the audio-frequency range, and amplitude modulation free from incidental fm can be obtained with a simple crystal-diode modulator from zero to 5 Mc. Connected to a mixer, the Unit Oscillator can be used as the local oscillator in a heterodyne receiver to convert the Type 1216-A Unit I-F Amplifier on a low-frequency communications receiver into a vhf or uhf detector. Pulsing and linear 100-percent amplitude modulation can be obtained with an external balanced modulator.

1.2 DESCRIPTION. The tuning system of the Type 1209-B Unit Oscillator is a "butterfly" circuit, which combines a variable air capacitor and a variable inductor in a single unit with no sliding contacts. Inductance varies from 0.012 μ h at the low-frequency end to 0.004 μ h at the high-frequency end, and capacitance varies from 40 μ mf to 7 μ mf. The inductance of the Type 1209-BL unit oscillator is exactly twice as large. The vernier dial requires about 8 turns to rotate the main dial over its full 270 degrees. The rotor of the tuning unit is geared down for 80-degree rotation. The frequency calibration is accurate within 1 percent.

With the exception of frequency and output-characteristic differences stated in the Specifications, the Types 1209-B and 1209-BL are identical to each other, and all information contained herein applies to both.

Plate and grid of the oscillator tube are connected to the tuned circuit, and the cathode is left floating. The oscillator circuit is of the Colpitts type, with feedback determined essentially by the electrode capacitances of the tube. A small amount of cathode-plate capacitance has been added.

GENERAL RADIO COMPANY

The output system is a short coaxial line, with a coupling loop on one end and a Type 874 Coaxial Connector on the other. Coupling between the loop and the oscillator can be adjusted over a wide range, and the loop can be clamped in the desired position. Maximum power can be delivered to load impedances normally encountered in coaxial systems.

1.3 ACCESSORIES.

1.3.1 AMPLITUDE MODULATION. A simple audio oscillator can be connected in the plate circuit of the unit oscillator to give amplitude modulation over the audio-frequency range. The audio oscillator circuit must supply a d-c path and must be able to carry 30 milliamperes dc.

Plate modulation of the oscillator introduces some incidental frequency modulation. Incidental fm is considerably reduced if square-wave or pulse modulation is used instead of sinusoidal amplitude modulation, but the power required is large and the accessories are more complex and more expensive.

Amplitude modulation free from incidental fm can be obtained by means of a Type 1000-P6 Crystal Diode Modulator or Type 1000-P7 Balanced Modulator connected between oscillator and load.

1.3.2 SWEEP AND DIAL DRIVES. The frequency dial of the Type 1209-B Unit Oscillator can be mechanically swept back and forth by the Type 1750-A Sweep Drive, the Type 908-P Synchronous Dial Drive, or the Type 907-R Dial Drive.

The Sweep Drive can be coupled either to the slow-motion dial or to the main frequency dial of the Unit Oscillator. When the main frequency dial is coupled to the Sweep Drive, the sweep rate should be restricted to one excursion per second or less. The slow-motion dial can be driven at rates up to 5 cycles per second. The magnitude and center position of the sweep arc, as well as the sweep rate, can be set by controls on the Sweep Drive panel. The Sweep Drive also provides horizontal deflection voltage, proportional to shaft rotation, for an oscilloscope. The combination of a Type 1209-B Unit Oscillator, Sweep or Dial Drive, and Type 1263-A Amplitude-Regulating Power Supply is a versatile sweep generator for recording or oscilloscopic display of frequency characteristics.

When the Type 1209-B Unit Oscillator is driven by a sweep or dial drive, all moving parts in the oscillator must be lubricated in accordance with paragraph 4.4.

1.3.3 OTHER ACCESSORIES. Supplied with the Unit Oscillator are a 874-R22 three-foot coaxial double-shielded Patch Cord, a Type 874-P Panel Connector, a Type 874-C Cable Connector, a Jones socket, and a phone plug.

TYPE 1209-B UNIT OSCILLATOR

TABLE OF ACCESSORIES

Accessory and Function	Instrument	Remarks
POWER SUPPLIES		
Standard	Type 1203-B Unit Power Supply	115-v, 50-60-cps line
Stabilized Plate Voltage	Type 1201-B Unit Regulated Power Supply	105-125-v, 50-60-cps line (reduced output)
Adjustable Plate Voltage	Type 1204-B Unit Variable Power Supply	115-v, 60-cps line
Constant Output Level vs Frequency	Type 1263-A Amplitude Regulating Power Supply with Type 874-VR Voltmeter Rectifier, Type 874-Q6 Adaptor, and Type 274-NF Patch Cord	115- or 230-v, 50-60-cps line (reduced output)
MODULATORS		
Plate Modulation	Type 1214-A Unit Oscillator	400 and 1000 cps output, 115-v, 40-60-cps line
Square-Wave or Pulse Modulation	Type 1219-A Unit Pulse Amplifier	Requires modulation source.
Absorption Modulation with no Incidental Fm	Type 1000-P6 Crystal-Diode Modulator	Requires modulation source. Modulation freq range 0-5 Mc. Maximum output 10 mv.
Balanced Modulation for linear 100-percent amplitude modulation and for pulses with high degree of carrier suppression	Type 1000-P7 Balanced Modulator	Requires modulation source. Modulation frequency range 0-20 Mc.
SWEEP DRIVE		
Automatic Frequency Sweep	Type 1750-A Sweep Drive Type 908-P Synchronous Dial Drive Type 907-R Dial Drive	Type 1263-A Amplitude-Regulating Power Supply recommended to keep oscillator output level constant.
RELAY RACK PANEL	Type 480-P4UC2	for Types 1203-B and 1209-B or for 1201-B and 1209-B
ADAPTORS - available for connecting Type 874 coaxial output terminals to other coaxial systems. See Table at rear of manual.		

Section 2 OPERATING PROCEDURE

2.1 INSTALLATION. The Type 1209-B Unit Oscillator, when connected to a suitable power supply, is ready for use. A cord and connector are supplied with the instrument for direct connection to a General Radio Unit Power Supply. Connect the oscillator to the equipment under test by means of the three-foot coaxial cable supplied. If necessary, install one of the two connectors supplied on the equipment under test; or use one of the many adaptors available for various coaxial systems.

If a power supply other than a Unit Power Supply is used, it should be capable of supplying 330 volts at 36 milliamperes and 6.3 volts at 0.4 ampere. To reduce these requirements, the series and shunt resistors in the base of the oscillator could be disconnected, but care must be taken not to overload the tube under various operating conditions. Plate dissipation of the oscillator tube should be limited to 5 watts, and best operation will be obtained with a plate current of 30 milliamperes at 165 volts.

2.2 OPERATION. After turning on the power supply, adjust the frequency by means of the frequency dial, and adjust the output by rotating the output coupling loop. For low output the coupling loop can be partly withdrawn.

The frequency of the oscillator varies for some time after the power has been applied, until the temperature has stabilized. This warmup drift is usually well under $\pm 0.2\%$. It depends on frequency and varies considerably from one oscillator to the other. A representative curve of warmup drift is shown in Figure 2.

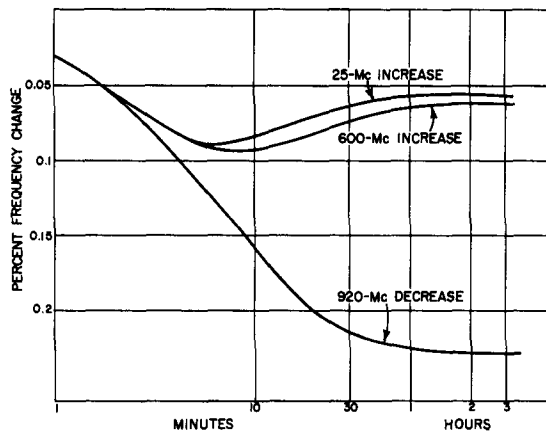

Figure 2.
Typical Warmup
Drift Rate
of Oscillator

TYPE 1209-B UNIT OSCILLATOR

For plate modulation the audio modulating voltage should be inserted at the jack at the side of the base. Full plate current must flow through the modulating source. A modulating voltage of about 40 volts is required for 30-percent modulation. The input impedance is about 8000 ohms.

2.3 FREQUENCY DEVIATION. For some applications a well-regulated and filtered power supply should be used to avoid frequency variations caused by line-voltage fluctuation and to produce a clearer beat note at the highest frequencies. With an unregulated power supply, a line-voltage variation of 20 percent causes a frequency change of about 0.01 percent at frequencies up to 600 Mc, and a frequency change of about 0.05 percent at the top end of the frequency range.

As mentioned above, amplitude modulation over the audio range can be obtained by an audio-frequency voltage superimposed in the d-c power supply. Incidental fm, inherent in this system, is about 0.01 percent for 50-percent amplitude modulation at carrier frequencies up to 400 Mc, and 0.1 percent at the high-frequency end.

2.4 SQUARE-WAVE AND PULSE MODULATION. The rise time of the Type 1209-B Unit Oscillator depends on frequency and load conditions, and is never adequate to reproduce short pulses faithfully. However, modulation with square waves and long pulses might be desirable for applications where incidental fm has to be kept to a minimum.

For best results, the plate power supply should be disconnected. Then ground the junction of inductors L1 and L2 in the r-f compartment and introduce square waves or pulses at the modulation jack. With 150 volts at 20 to 30 ma, either pulses or square waves, output will be the same as that obtainable with a Unit Power Supply. A Type 1219-A Unit Pulse Amplifier driven by a Type 1210-C Unit R-C Oscillator for square waves or by a Type 1217-A Unit Pulser would be suitable for this purpose.

Section 3 APPLICATIONS

3.1 GENERAL. The utility and versatility of the Type 1209-B Unit Oscillator are greatly increased by the large selection of Type 874 coaxial elements, available from General Radio Company. These elements are part of a complete, integrated line of equipment for the measurement of voltage, power, and standing-wave ratio at very-high and ultra-high frequencies. Although the Unit Oscillator is intended primarily as a source of power for this measuring equipment and for other impedance-measuring devices such as the Type 1602-A U-H-F Admittance Meter, use of the coaxial elements can adapt the Unit Oscillator to various applications in the radio-frequency laboratory in place of more expensive equipment that is not always available. The tuning circuit of the Type 1209-B

GENERAL RADIO COMPANY

Unit Oscillator uses ball bearings, and thus can be motor-driven, for sweep applications, by sweep and dial drives (refer to paragraph 1.3.2).

Three applications are described in detail in the following paragraphs. Others will be suggested by a study of the complete list of Type 874 Coaxial elements, included in the General Radio Catalog. A condensed list of Type 874 elements appears in the rear of this manual.

3.2 UNIT OSCILLATOR AS SIGNAL GENERATOR FOR RECEIVER TESTING. The Type 1209-B Unit Oscillator, as a well-shielded power source, can be used as a signal generator to test receivers if means are available to measure and attenuate the output. The Type 874-VR Voltmeter Rectifier, Type 874-VI Voltmeter Indicator, and Type 874-GA Adjustable Attenuator are suitable for this purpose, and should be connected to the Unit Oscillator as shown in Figure 3. Also, a Type 874-D50 Adjustable Stub is required to produce a current maximum at that point of the attenuator where the adjustable output loop is coupled. A tuning

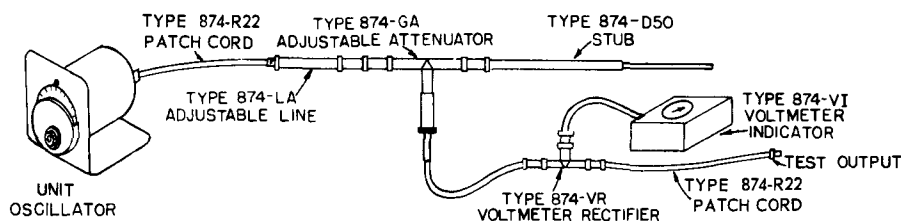

Figure 3. Setup of Unit Oscillator and Accessories for Use as Standard-Signal Generator.

element between the oscillator and the attenuator is required to increase the output to a value that can be read on the voltmeter. At higher frequencies coverage is obtained by a Type 874-LA Adjustable Line. At lower frequencies additional lengths of line must be used.

Current from the Unit Oscillator is fed through the attenuator into the short circuit at the stub. The attenuator is calibrated in decibels. At minimum attenuation the attenuator output is measured by a crystal diode in the voltmeter rectifier and read on the meter of the voltmeter indicator. Means are provided to standardize the crystal indication. A 50-ohm resistor after the crystal determines the output impedance.

With the above-described arrangement, the maximum available output is several tenths of a volt. The attenuator calibration covers 120 db, but shielding of the Unit Oscillator and of other components is not sufficient for accurate measurements in the microvolt region.

3.3 UNIT OSCILLATOR AS A TELEVISION SIGNAL GENERATOR. Used in combination with a Type 1000-P6 Crystal Diode Modulator and a Type 874-G20 20-db Fixed Attenuator, the Unit Oscillator is a convenient source of television signals over its entire carrier-frequency range if video modulating voltage is available. (see Figure 4.) The modulating

TYPE 1209-B UNIT OSCILLATOR

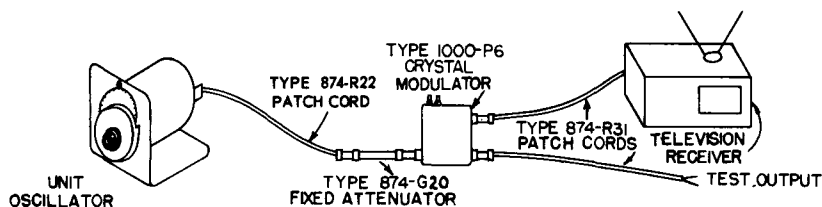

Figure 4. Setup of Unit Oscillator with Video Modulator for Use as Television Signal Generator.

voltage required can be obtained from a standard television receiver tuned to the local channel.

Since the modulator and oscillator are separated from each other by an attenuator pad, amplitude modulation is free from incidental fm. Output is about 10 millivolts.

3.4 UNIT OSCILLATOR AS A FREQUENCY CONVERTER. Connected to a Type 874-MR Mixer Rectifier, the Unit Oscillator can provide the local signal in a heterodyne converter to adapt the Type 1216-A Unit I-F Amplifier for use as a sensitive detector for v-h-f and u-h-f signals. (See Figure 5.) Without additional tuning, the conversion loss is about 6 db at an intermediate frequency of 30 Mc. The Type 1216-A I-F Amplifier has a built-in precision attenuator and a panel meter. Its bandwidth is 0.7 Mc and it has excellent sensitivity. Provision is made for the measurement of the rectified mixer current in the i-f amplifier, and a separate built-in power supply is available for operating the Unit Oscillator.

For the vhf range of 50-250 Mc, the Type 1215-B Unit Oscillator is an excellent companion instrument to the Type 1209-B. The two oscillators are similar in appearance and construction.

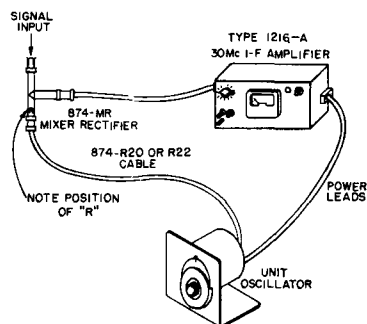

Figure 5. Setup of Unit Oscillator and Mixer Rectifier for Use as Frequency Converter.

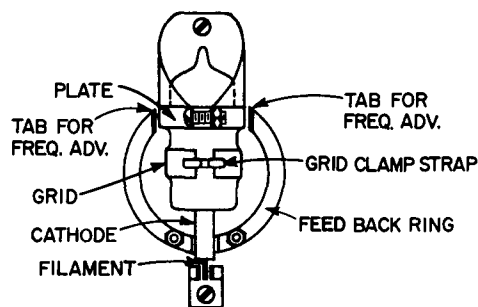

Figure 6. Installation Detail of Oscillator Tube.

GENERAL RADIO COMPANY

Section 4
SERVICE AND MAINTENANCE

4.1 GENERAL. The two-year warranty given with every General Radio instrument is our way of proclaiming the quality of materials and workmanship we know to exist in our products. When difficulties do occur, our factory-trained service engineers at our main plant and at several district offices stand ready to assist in any way possible.

In case of difficulties that cannot be solved by the use of these service instructions, please write or phone our Service Department, giving full information of the malfunction and of steps taken to remedy the trouble. Be sure to mention the serial and type numbers of the instrument.

Before returning an instrument to General Radio for service, please write to our Service Department or nearest district office, requesting a Returned Material Tag. Use of this tag will insure proper handling and identification. Also, for instruments not covered by the warranty, a purchase order should be forwarded to avoid unnecessary delay.

4.2 INSTALLATION OF OSCILLATOR TUBE. When it is necessary to replace the Type RT-434 oscillator tube, install the new tube as follows (See Figure 6):

- a. Remove the screw holding the plate clamp.
- b. Loosen the grid clamp strap until the tube can be slid into position. Place the cathode connection just short of the filament clip.
- c. Carefully tighten the grid clamp, by bending the ends of the grid clamp strap.
- d. Replace the plate screw and carefully tighten the plate clamp.

CAUTION

Be careful when tightening clamps. Glass seals are fragile.

e. Restore frequency calibration, if necessary, in accordance with paragraph 4.3.

4.3 FREQUENCY CALIBRATION. Replacement of the oscillator tube may affect frequency calibration. It can be restored by adjustment of one of the flexible tabs on the feedback ring. Before adjusting this trimmer capacitor, allow the instrument to warm up, since warmup drift may be as much as 0.2 percent. The oscillator shield affects frequency considerably, especially at the low-frequency end.

4.4 LUBRICATION. When the Type 1209-B Unit Oscillator is driven by a sweep or dial drive, all moving parts must be properly lubricated. Proper lubrication includes an occasional drop of light oil at the ball bearings, and occasional relubrication of the pinion gear in the dial assembly.

TYPE 1209-A UNIT OSCILLATOR

TYPE 874 ACCESSORIES

ADAPTORS			CABLE (DOUBLE-SHIELDED)			
Type	Contains Type 874 Connector and	Fits	Type	Z	Attenuation/100 ft	
874-QBJ	BNC Jack	BNC Plug	874-A2	50Ω ±5%	2.6 db at 100 Mc	
874-QBP	BNC Plug	BNC Jack	874-A3	50Ω ±5%	5.3 db at 100 Mc	
874-QCJ	C Jack	C Plug	CONNECTORS			
874-QCP	C Plug	C Jack				
874-QHJ	HN Jack	HN Plug	CABLE CONNECTORS			
874-QHP	HN Plug	HN Jack				
874-QLJ	LC Jack	LC Plug	TYPE			
874-QLP	LC Plug	LC Jack				
874-QLTJ	LT Jack	LT Plug	FOR CABLE TYPE			
874-QLTP	LT Plug	LT Jack				
874-QNJ	N Jack	N Plug	874-C	874-A2		
874-QNP	N Plug	N Jack	874-C8	RG8/U		
874-QSCJ	SC Jack	SC Plug	874-C9	RG9/U, RG116/U		
874-QSCP	SC Plug	SC Jack	874-C58	874-A3, RG29/U, RG55/U, RG58/U, RG58A/U		
874-QTNJ	TNC Jack	TNC Plug	874-C62	RG59/U, RG62/U		
874-QTNP	TNC Plug	TNC Jack	PANEL CONNECTORS			
874-QUJ	UHF Jack	UHF Plug				
874-QUP	UHF Plug	UHF Jack	(-P -HEX NUT MTG, -PB -FLANGE MTG)			
874-QU1A		7/8" 50Ω UHF rigid air line				
874-QU2		1-5/8" 50Ω UHF rigid air line	874-P, -PB	874-A2		
874-QU3A		3-1/8" 50Ω UHF rigid air line	874-P8, -PB8	RG8/U		
874-QV2A		1-5/8" 51.5Ω VHF rigid air line	874-P9, -PB9	RG9/U, RG116/U		
874-QV3		3-1/8" 51.5Ω VHF rigid air line	874-P58, -PB58	874-A3, RG29/U, RG55/U, RG58/U, RG58A/U		
874-Q2	274 Jack	274 Plug	874-P62, -PB62	RG59/U, RG62/U		
874-Q6	Pin & Sleeve	274-NF	PATCH CORDS (3 FT)			
874-Q7	774 Jack	774 Plug				
MISCELLANEOUS						
TYPE 874-		TYPE 874-		TYPE 874-		
BM	300Ω Balanced Termination	LK	Constant-Z Adjust. Line	UB-P3	300Ω Balun Terminal Pad	
D	Adjustable Stubs	LR	Radiating Line	VC	Variable Capacitor	
EL	90° Ell	LT	Trombone-Constant-Z Line	W100	100Ω Coax. Standard	
F	Low-Pass Filter	M	Component Mount	W200	200Ω Coax. Standard	
FR	Rejection Filter	MA	Adjustable Coupling Probe	WM	50Ω Termination	
G	Fixed Attenuator	MB	Coupling Probe	WN	Short-Circuit Termination	
GA	Adjustable Attenuator	T	Tee	WO	Open-Circuit Termination	
JR	Rotary Joint	UB	Balun	X	Insertion Unit	
K	Coupling Capacitor	UB-P2	200Ω Terminal Unit	XL	Series Inductor	
L	Air Line			Y	Cliplock	
LA	Adjustable Line			Z	Stand	

The above is a partial listing. For complete list and specifications, refer to the General Radio Catalog.

GENERAL RADIO COMPANY

Section 5
PARTS LIST

REF DESIG	DESCRIPTION	PART NO.
C1	CAPACITOR, Fixed mica, 200 μf $\pm 10\%$	COU-24
C2	CAPACITOR, Fixed mica, 200 μf $\pm 10\%$, 500 dcwv	COU-8-2
C3A	CAPACITANCE, Built-in air adjustment	
C3B	CAPACITANCE, Built-in air adjustment	
C4	CAPACITOR, Fixed mica, 500 μf $\pm 10\%$	COU-24
C5	CAPACITOR, Fixed mica, 500 μf $\pm 10\%$, 500 dcwv	COU-8-2
C7	CAPACITOR, Fixed mica, 10 μf , built-in	
C8	CAPACITOR, Fixed mica, 500 μf $\pm 10\%$, 500 dcwv	COU-8-2
C9	CAPACITOR, Fixed mica, 500 μf $\pm 10\%$	COU-24
C10	CAPACITOR, Fixed electrolytic, 20 μf $+100\%$ -10% , 450 dcwv	COE-5
J1	JACK	CDSJ-10
L1	INDUCTOR, 45 μh	ZCHA-9
L2	INDUCTOR, 45 μh	ZCHA-9
L4	INDUCTOR, 20 μh	ZCHA-29
L6	INDUCTOR, 45 μh	ZCHA-9
L7	INDUCTOR (R-F pickup loop)	874-403
L8	INDUCTOR, 20 μh	ZCHA-29
LC1	BUTTERFLY, 250 - 920 Mc, built in	
LR1	HEATER FILTER	1021-216
PL1	PLUG	1209-34
R1	RESISTOR, Fixed, wire-wound, 560 Ω $\pm 10\%$, 2 w	REW-6C
R4	RESISTOR, Fixed composition, 1 k $\pm 10\%$, 1/2 w	REC-20BF
R5	RESISTOR, Fixed power, 4.7 k $\pm 10\%$, 10 w	REPO-22
R6	RESISTOR, Fixed composition, 21.5 k $\pm 10\%$ (two 43-k $\pm 5\%$ resistors in parallel), 2 w	REC-41BF

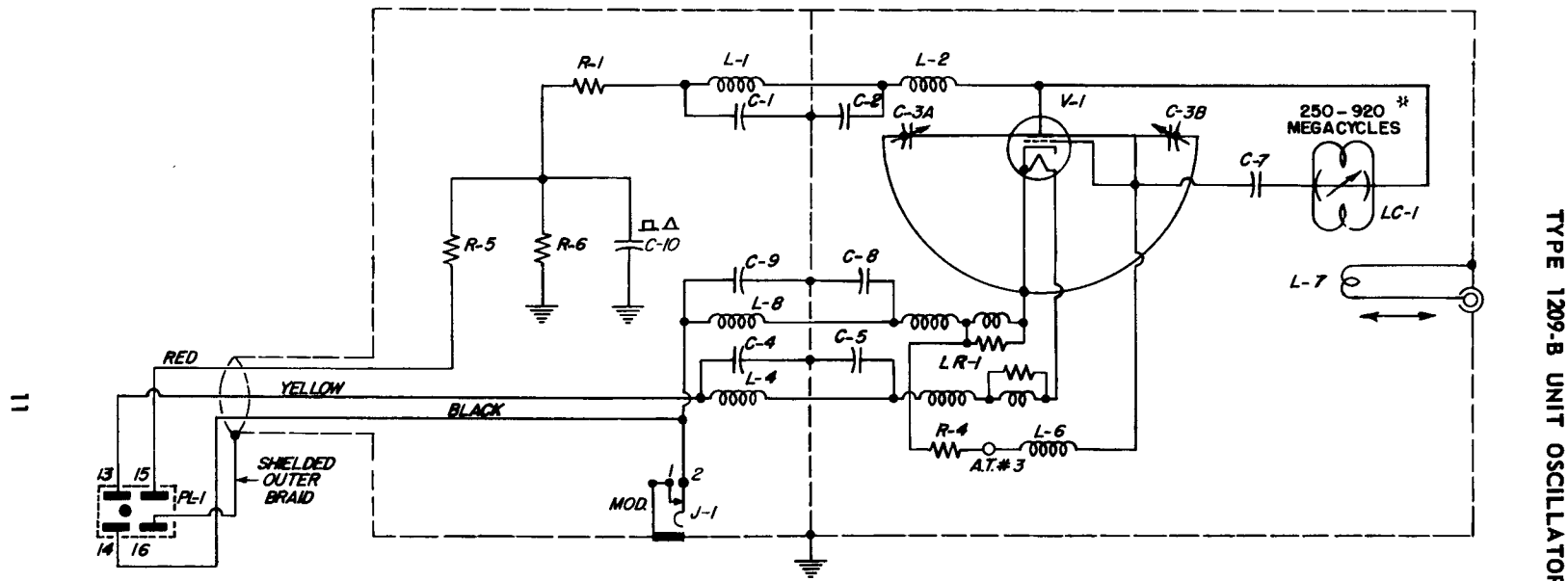

TYPE 1209-B UNIT OSCILLATOR

* Type 1209-BL: 180-600 Mc

TUBE
V-1 SYLVANIA RT-434

Figure 7. Schematic Diagram of Type 1209-B Unit Oscillator.

GENERAL RADIO UNIT INSTRUMENTS

Type 1201	Unit Regulated Power Supply
Type 1203	Unit Power Supply
Type 1204	Unit Variable Power Supply
Type 1205	Adjustable Regulated Power Supply
Type 1206	Unit Amplifier
Type 1208	Unit Oscillator 65 to 500 Mc
Type 1209-B	Unit Oscillator 250 to 920 Mc
Type 1209-BL	Unit Oscillator 180 to 600 Mc
Type 1210	Unit RC Oscillator 20 cps to .5 Mc
Type 1211	Unit Oscillator 0.5 to 50 Mc
Type 1212	Unit Null Detector
Type 1213	Unit Time/Frequency Calibrator
Type 1214-A	Unit Oscillator 400 and 1000 cps
Type 1214-D	Unit Oscillator 120 cps
Type 1214-E	Unit Oscillator 270 and 1000 cps
Type 1214-M	Unit Oscillator 1 Mc
Type 1215	Unit Oscillator 50 to 250 Mc
Type 1216	Unit I-F Amplifier
Type 1217	Unit Pulser
Type 1218	Unit Oscillator 900 to 2000 Mc
Type 1219	Unit Pulse Amplifier
Type 1220	Unit Klystron Oscillator

GENERAL RADIO COMPANY

WEST CONCORD, MASSACHUSETTS

EMerson 9-4400

CLearwater 9-8900

DISTRICT OFFICES

NEW YORK

Broad Ave. at Linden, Ridgefield, N. J.
Telephone N.Y. WOrth 4-2722
N.J. WHitney 3-3140

PHILADELPHIA

1150 York Rd., Abington, Penna.
Telephone HAncock 4-7419

WASHINGTON

8055 13th St., Silver Spring, Md.
Telephone JUniper 5-1088

CHICAGO

6605 West North Ave., Oak Park, Ill.
Telephone VillAge 8-9400

LOS ANGELES

1000 N. Seward St., Los Angeles 38,
Calif.
Telephone HOLlywood 9-6201

SAN FRANCISCO

1186 Los Altos Ave., Los Altos, Calif.
Telephone WHitecliff 8-8233

CANADA

99 Floral Pkwy., Toronto 15, Ont.
Telephone CHerry 6-2171

REPAIR SERVICES

EAST COAST

General Radio Company
Service Department
22 Baker Ave., W. Concord, Mass.
Telephone EMerson 9-4400

NEW YORK

General Radio Company
Service Department
Broad Ave. at Linden, Ridgefield, N. J.
Telephone N.Y. WOrth 4-2722
N.J. WHitney 3-3140

MIDWEST

General Radio Company
Service Department
6605 West North Ave., Oak Park, Ill.
Telephone VillAge 8-9400

WEST COAST

Western Instrument Co.
826 N. Victory Blvd., Burbank, Calif.
Telephone Victoria 9-3013

CANADA

Boily Engineering, Ltd.
First Street, Ajax, Ontario
Telephone Toronto EMpire 2-3741

Printed in USA